

SBVR-M8

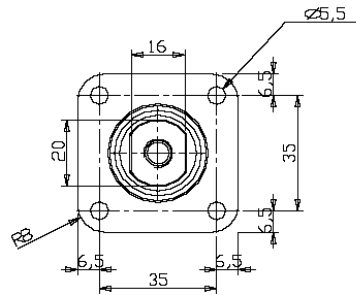

SBMR-M8

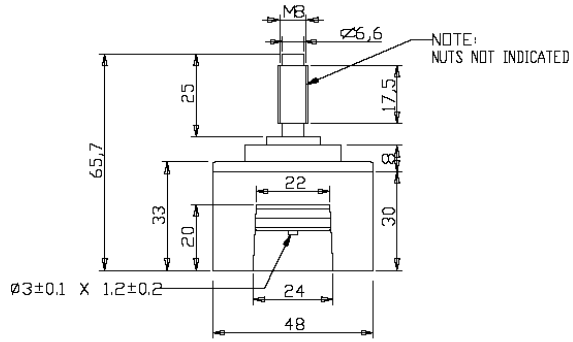
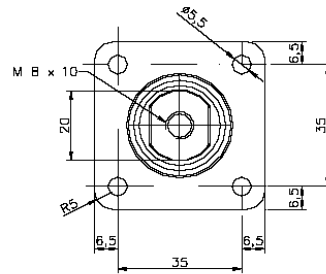
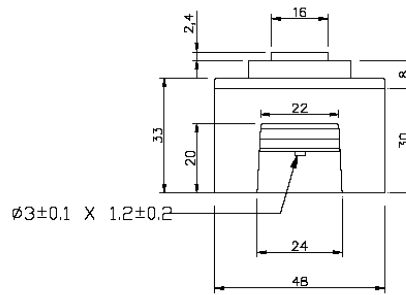

SBVR-M10

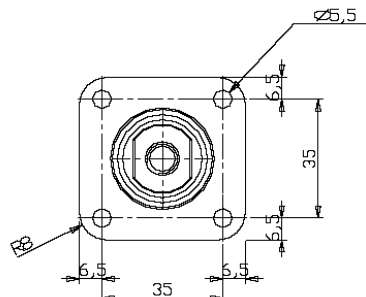
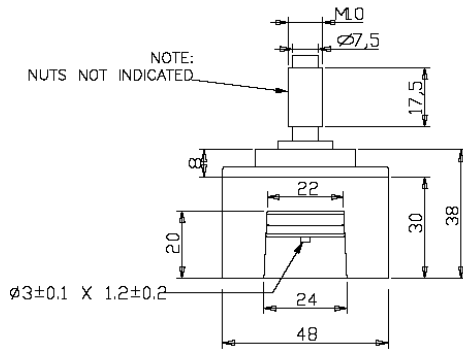

SBMR-M10

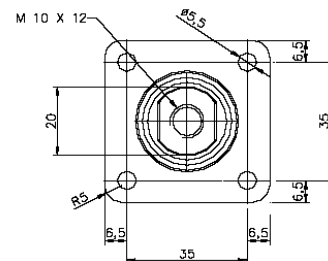
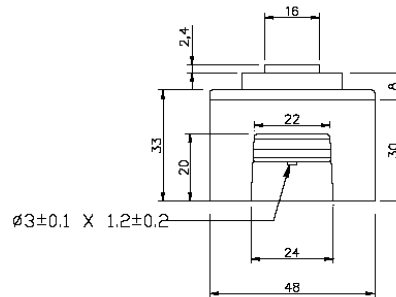

Dimensions in mm - Tolerances according to ISO 2768MK